

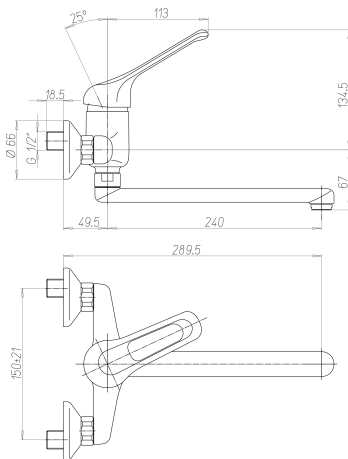

HEALTHCARE TAPWARE

Hospital sink mixer, wall-mount, with downward spout, swivel - 75627



Benefits of the product

- Ergonomic: easy to use elbow control handle
- Hand hygiene: avoiding manual contact
- Multifunction ceramic cartridge: 7-setting temperature limit stop, dual flow (6/12L) and flow settings from 2l to 13.8l/min.
- Water savings, safe operation and controlled water consumption.
- Swivel spout with an extended projection: easy washing
- Star shaped flow straightener: limits the water spray, no water retention.

Description

Sink mixer, 150 mm span, without drain, wall mount with 170mm long medical handle avoiding manual contact, using elbow, forearm or wrist. Swivel cast spout L 200mm. Multifunction ceramic cartridge Ø 40: 7-setting temperature limit stop, dual flow and flow settings from 2l to 13.8l/min. Tapware fitted as standard star-shaped flow straightener. Body, spout and controls in polished chrome plated brass. Connection LN G'3 / 4 comes with rosettes and off-centre fittings M G'1/2 10 year warranty. Sanifirst brand single hole sink mixer, 150 mm span, swivel, cast spout REF: 75627 or approved equivalent.

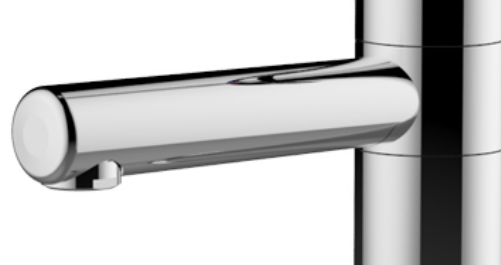

TECHNICAL DATASHEET

Additional Information

Product reference	75627
Previous reference	NC
Brand	Sanifirst
Warranty	10 years against manufacturing defects
Special feature 1	Swivel spout
Lenght of spout (mm)	200
Projection (mm)	240
Clip-on spout	No
Flow straightener	Star shaped flow straightener, M24 x 1
Lever	Elbow / forearm / wrist handle
Connection	Connection LN G'3 / 4 comes with rosettes and off-centre fittings M G'1/2
Minimum pressure	1 bar
Recommended pressure	3 bar
Maximum pressure	5 bar
Cartridge	75312 Ø 40mm, dual flow, flow limiter and temperature limiter
Coating	Nickel > 10 microns - Chrome > 0.3 microns