



LABORATORY TAPWARE

Column type single tap with swivel spout - 76102



Description

Polypropylene column tap with fixed spout for acidic / basic fluid and deionized / reverse osmosis water. Connection by 1 m length female hose (length can be changed on request). Water tight guided valve head NF, threaded connection M G'1 / 2, \varnothing 6mm removable serrated tip, comes with Rilsan hose. • Water supply from 0.5 to 1.5 bar 200mm projection. Polypropylene brace, base and flanged washer according to colour codes of the European standard NF EN 13792. Maximum tightening 55mm. Brass body and nozzle, polypropylene interior with black Nylolac coating (stronger than simple Epoxy finish). Unique and patented reinforced mounting kit, the serrated tips are designed for a steel claw washer thereby preventing rotation of the tapware. 5 year warranty. First Labo brand fixed spout column tap REF: 76102 (formerly H9783PT) or approved equivalent.

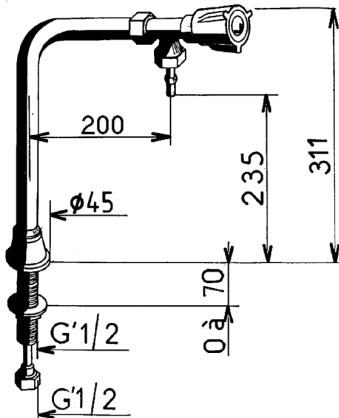



TECHNICAL DATASHEET

Additional Information

Product reference	76102
Previous reference	H9783PT
Brand	FirstLabo
Warranty	5 years against manufacturing defect
Special feature 1	Direct control tapware
Special feature 2	Tabletop
Nozzle 1	Removable connector Ø6 mm
Base color EN	Green
Base washer color EN	White
Insert color EN	White
Knob color EN	Green
Knob plate color EN	White
Additional information	With Rilsan tube
Height to nozzle (mm)	235
Opening mechanism	2.5 turns head
Projection (mm)	200
Connection	LN G'1/2
Adjustable flow rate	No
Dual flow rate	No
Minimum pressure	1 bar
Recommended pressure	1,5 bar
Maximum pressure	3 bar
Blocking temperature	No
Lenght of threaded rod (mm)	102
Max tightening	55