

LABORATORY TAPWARE

120 mm span deck-mounted mixer with swivel spout - 76404



Description

120mm span mixer tap with smooth directional removable spout, for potable water. Threaded M G¹/₂ stem connection, ø 10mm removable grooved tip, projection 200mm. Polypropylene crosses, bases and base washers using the NF EN 13792 European standard colour codes. Maximum tightening 55mm. Brass body and tips with black Nylolac coating (stronger than a basic epoxy finish). 5 year guarantee. First Labo brand type deck-mounted mixer tap with 120mm span with smooth directional removable spout REF: 76404 or approved equivalent.

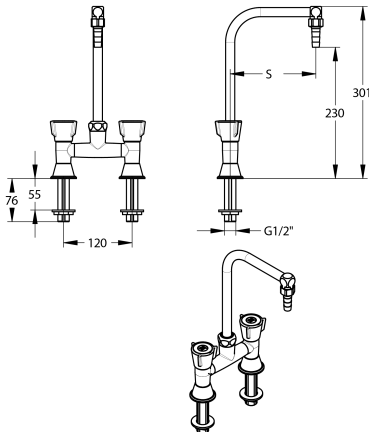



TECHNICAL DATASHEET

Additional Information

Product reference	76404
Previous reference	NC
Brand	FirstLabo
Warranty	5 years against manufacturing defect
Special feature 1	Mixer
Special feature 2	Tabletop
Special feature 3	Swivel spout
Nozzle 1	Removable connector Ø10 mm
Base color EN	Green
Base washer color EN	Red
Base washer color 2 EN	Blue
Insert color EN	Red
Insert color 2 EN	Blue
Knob color EN	Green
Knob plate color EN	Green
Height to nozzle (mm)	230
Opening mechanism	2.5 turns head
Projection (mm)	200
Connection	Threaded connection M G'1 / 2Threaded connection M G'1 / 2Threaded connection M G'1 / 2
Adjustable flow rate	No
Dual flow rate	No
Minimum pressure	1 bar
Recommended pressure	3 bar
Maximum pressure	5 bar
Blocking temperature	No
Lenght of threaded rod (mm)	102
Max tightening	55
Packing	1