



LABORATORY TAPWARE

Candlestick type table top - 190 mm projection fixed spout and fixed nozzle - 76786



Benefits of the product

- Ergonomic knob for an easier opening/closing
- The shape of the base ensures a better sealing of the washbasin
- White colour body: purity and hygiene
- Nice and modern spout bending
- Thickness of the spout: 20 mm diameter for all the spout
- Resistance to corrosion and impact: RILSAN coating
- Smooth surface, limits deposits

Description

Single candlestick deck-mounted tap with smooth fixed spout for drinkable water. National Education approved. Thread connection M G'1/2, \varnothing 6mm fixed nozzle, 190mm projection. Polypropylene knob according to colour codes of the European standard NF 13792. Maximum tightening 50mm. Brass body and nozzle with white Nylolac coating (stronger than simple Epoxy finish). Unique and patented reinforced mounting kit, the serrated tips are designed for a steel claw washer thereby preventing rotation of the tapware. 5 year warranty. FirstLabo brand single tap deck-mounted candlestick with smooth fixed removable spout REF: 76786 or approved equivalent.

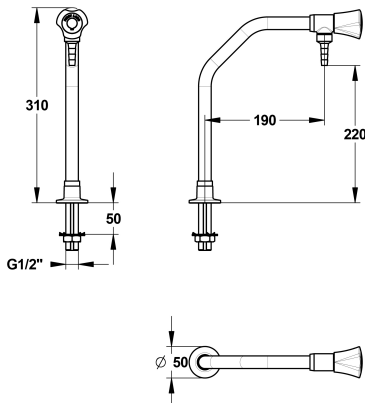



TECHNICAL DATASHEET

Additional Information

Product reference	76786
Previous reference	NC
Brand	FirstLabo
Warranty	5 years against manufacturing defect
Special feature 1	Candlestick
Special feature 2	Tabletop
Special feature 3	Fixed spout
Nozzle 1	Fixed connector Ø6 mm
Insert color EN	Blue (drinkable water)
Knob color EN	Green (drinkable water)
Knob plate color EN	Green (drinkable water)
Height to nozzle (mm)	220
Opening mechanism	2.5 turns head
Projection (mm)	190
Connection	M G'1/2" threaded rod
Flow rate	The cartridge is used to adjust the flow
Adjustable flow rate	Yes
Dual flow rate	No
Minimum pressure	1 bar
Recommended pressure	3 bar
Maximum pressure	5 bar
Blocking temperature	No
Length of threaded rod (mm)	102
Max tightening	50
Packing	1