



LABORATORY TAPWARE

Table top twin tap - Projection 150 mm fixed and swivel spout, with removable nozzle - 76792



Benefits of the product

- Ergonomic knob for an easier opening/closing
- Smooth interior spout, fixed and swivel (at the choice of the technician, using a blocking screw)
- White colour body: purity and hygiene
- Nice and modern spout bending
- Thickness of the spout: 20 mm diameter for all the spout
- Resistance to corrosion and impact: RILSAN coating
- Smooth surface, limits deposits

Description

Dual tap deck-mounted mixer with smooth fixed and swivel (at the choice of the technician, using a blocking screw) removable spout, for drinking water. SPEX stainless steel hose, M10X1, LN G'3 / 8 L 600mm, ø10mm removable nozzle, 150mm projection. Height to nozzle: 153 mm. Polypropylene knobs according to colour codes of the European standard NF EN 13792. Maximum tightening 40mm. Brass body and nozzle with white Nylolac coating (stronger than simple Epoxy finish). 5 year warranty. First Labo brand dual tap deck-mounted with smooth fixed and swivel removable spout REF: 76792 or approved equivalent.

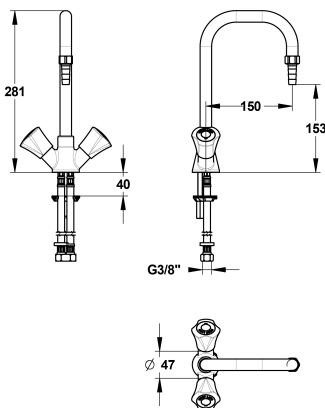



TECHNICAL DATASHEET

Additional Information

Product reference	76792
Previous reference	NC
Brand	FirstLabo
Warranty	5 years against manufacturing defect
Special feature 1	Mixer
Special feature 2	Fixed spout
Special feature 3	Swivel spout
Special feature 4	Tabletop
Nozzle 1	Removable connector Ø10 mm
Insert color EN	Red (drinkable water)
Insert color 2 EN	Blue (drinkable water)
Knob color EN	Green (drinkable water)
Knob plate color EN	Green (drinkable water)
Height to nozzle (mm)	153
Opening mechanism	2.5 turns head
Projection (mm)	150
Connection	SPEX stainless steel hose, M10X1, LN G'3 / 8 L 600mm
Flow rate	The cartridge is used to adjust the flow
Adjustable flow rate	Yes
Dual flow rate	No
Minimum pressure	1 bar
Recommended pressure	3 bar
Maximum pressure	5 bar
Blocking temperature	No
Max tightening	40
Packing	1