

Range: Washbasin single self-closing tap

Ref: 64716 - PRESTO NEO DUO S® deck-mounted - Dual timed-flow - 1.9L/min (PRESTOGREEN)

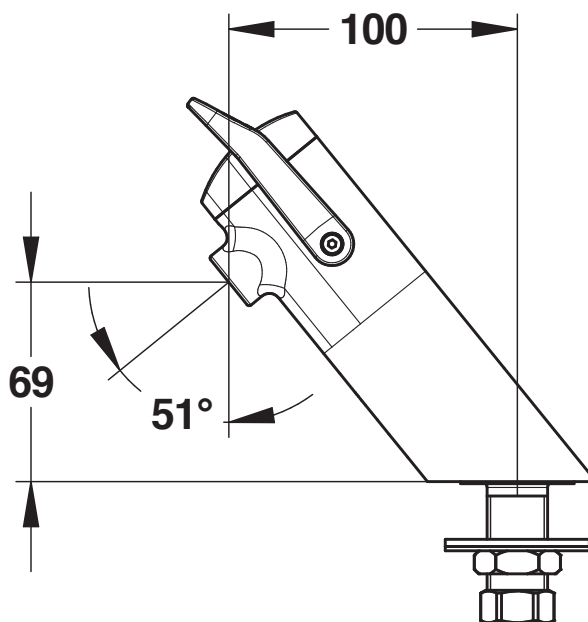

> Working pressure:

- 1 to 5 bar

> Flow:

- 1.9 l/min with flow regulator
- Anti water-hammer system

> Flow time:

- 7 seconds - lever upwards
- 11 seconds - lever downwards

> Hydraulic supply:

- G 1/2" x 40

> Thermal resistance:

- This tap can withstand a thermal shock of 75°C for 30 minutes as part of a thermal shock programme

> Safety:

- With S® antiblocking system to prevent blocking in continuous flow

> Convenience:

- Soft-touch
- Two-coloured ergonomic lever, in glass fiber reinforced polymer

> Delivered with:

- 1 Filter gasket
- 1 base gasket
- 1 fixture nut + 1 stainless steel washer
- 1 Nut for 12x14 tube
- 1 rubber flat gasket
- 1 coloured sticker

> Standards / Approvals:

- Chrome-plated brass body compliant with standards NF EN1982 / NF EN12164 / NF EN12165
- Nickel-Chrome surface treatment compliant with NF EN12540
- Neutral Salt Spray (NSS) resistant: 200 h according to NF ISO 9227

