

**Range:** Washbasin self-closing mixer tap

**Ref:** 68097 - PRESTO NEO DUO S® wall-mounted - Dual timed-flow

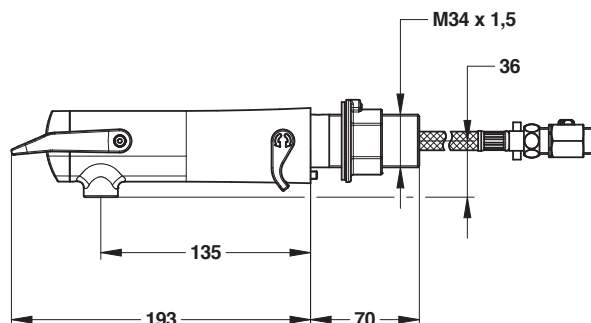

#### > Working pressure:

- 1 to 5 bar

#### > Flow:

- 3 l/min at 3 bar - 4 position-setting
- Anti water-hammer system

#### > Flow time:

- 7 seconds - lever upwards
- 11 seconds - lever downwards

#### > Hydraulic supply:

- 2 PEX hoses DN8 G3/8" - 350mm

#### > Thermal resistance:

- This tap can withstand a thermal shock of 75°C for 30 minutes as part of a thermal shock programme

#### > Safety:

- With S® antiblocking system to prevent blocking in continuous flow
- With temperature limiter (at 38°C for cold water at 15°C/3 bar and hot water at 60°C/3 bar)

#### > Convenience:

- Soft-touch
- Two-coloured ergonomic lever, in glass fiber reinforced polymer

#### > Installation:

- Cross-partition
- Wall thickness: 0 to 50 mm

#### > Delivered with:

- 2 PEX hoses with swivel nut and NF check valves
- 2 MM 3/8" (12x17) stop valves
- 2 Filter gaskets
- 1 clamping nut

#### > Standards / Approvals:

- Chrome-plated brass body compliant with standards NF EN1982 / NF EN12164 / NF EN12165
- Nickel-Chrome surface treatment compliant with NF EN12540
- Neutral Salt Spray (NSS) resistant: 200 h according to NF ISO 9227

