

Range: Sanifirst - Healthcare taps

Ref: 75884 - Electronic mixer, battery powered, fixed or adjustable removable nozzle, - Modul'Mix

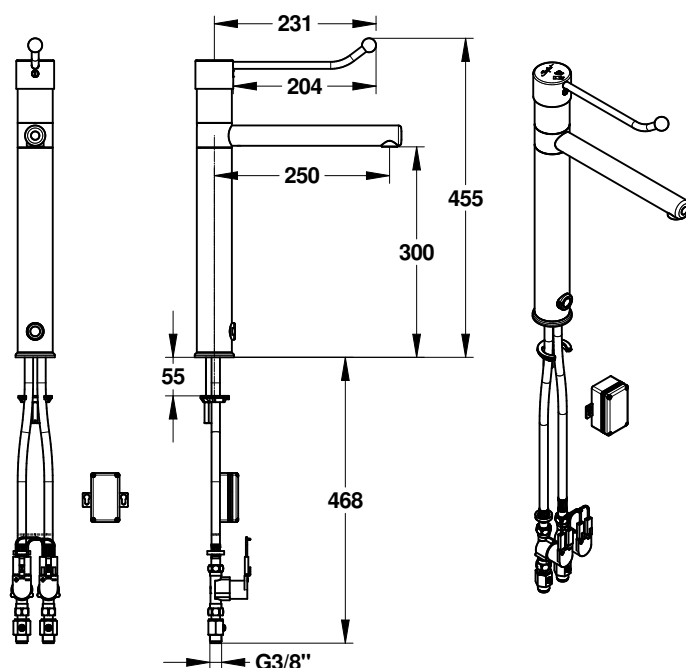

> Benefits of the product

- Modul'Mix range: modularity of parts and adaptability to needs
- Retrofittable and customizable
- Ergonomics: easy prehension of elbow control (for patients and the technical platform)
- Elbow control lever: avoiding manual contact
- Comfortable height to spout and projection for washbasin
- Multifunctional cartridge: temperature limiter with 7 adjustment positions
- Flow between 4 and 6L / min at 3 bar - in accordance with the French norm standard "Medical"; possible flow modification, in case of disassembly of the limiters, by adjusting screw between 4 and 20L / min.
- Fixed or adjustable spout (according to the technician's choice), removable with smooth interior: facilitates cleaning and disinfection, limits the deposit of the biofilm.
- Star-shaped flow straightener: limits the water spray, no water retention.
- Simple and fast maintenance
- Prevention program "anti-bacteria" customizable (purges, frequencies, duration, etc.). Limits bacterial growth (legionella, pseudomonas ...)

> Model

- Battery powered sensor hospital mixer
- Elbow control. Mixing by horizontal movement only: no need to lift the control to open the water
- Fixed or swivel smooth spout, technician's choice
- Height under spout: 300 mm
- Projection: 250 mm
- Multifunction ceramic cartridge Ø 40: temperature limiter with 7 adjustment positions, double flow (hard point at 50% opening)
- 2 Solenoid valves with silicone membrane M G'3 / 8
- Star-shaped flow straightener M24 X 100

> Flow rate

- Flow rate between 4 and 6L / min at 3 bar - conforms to the NF "Medical environment" standard
- Modification of the flow rate possible, if the limiters are removed, by adjusting screw between 4 and 20L / min.

> Recommended pressure

- 3 bar - avoid pressure differences greater than 1 bar between DHW and DCW.
- Minimum pressure: 1 bar.
- Maximum pressure: 5 bar.

> Materials

- Smooth body, spout and operating device in polished chrome-plated brass.

> Connection

- Hoses with M10X1 stainless steel braided SPEX sheath, G'3 / 8 captive nut, Lg 650mm, with basket filter seal fitted in the hoses, limiting clogging. Flow restrictors.
- Fixing reinforced by a stainless steel rod

> Warranty

- 3 years against any manufacturing defect.

