

Tipologia: Ausili per disabili - Maniglioni

Rif: 60345 - PRESTOBAR 135 - acciaio

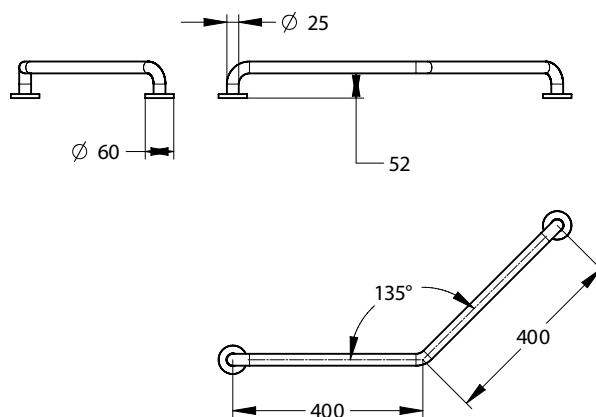

> Dimensioni:

- Ø 25 mm
- 400 x 400 mm

> Materiali e finiture:

- acciaio inox verniciato bianco
- flange di fissaggio in acciaio non a vista protette da chiocciole verniciate bianche

> Fornito con:

- istruzioni di montaggio

